



Welcome



NatPower

NatPower

GROWING BY NATURE

Welcome to our consultation event for the proposed Battery Energy Storage System.

We are keen to share our plans with you. They include not just energy storage, but also areas reserved for habitat enhancement and tree planting to support local wildlife and help screen the site.

Please take your time to review all the material on display and direct any questions to our project team. We would also like to hear what you think about our Community Energy Transition Foundation, which would invest in local initiatives to promote sustainable communities. Tell us how we can help in your local area.

We welcome any feedback you would like to share with us.

Alternatively, scan the QR code below which will take you to our project webpage where you can find all of the information on display here today, as well as a digital feedback form.

We will be listening to feedback in this consultation before submitting a planning application.



Find out more

→ www.natpower.uk/our-projects

NatPower

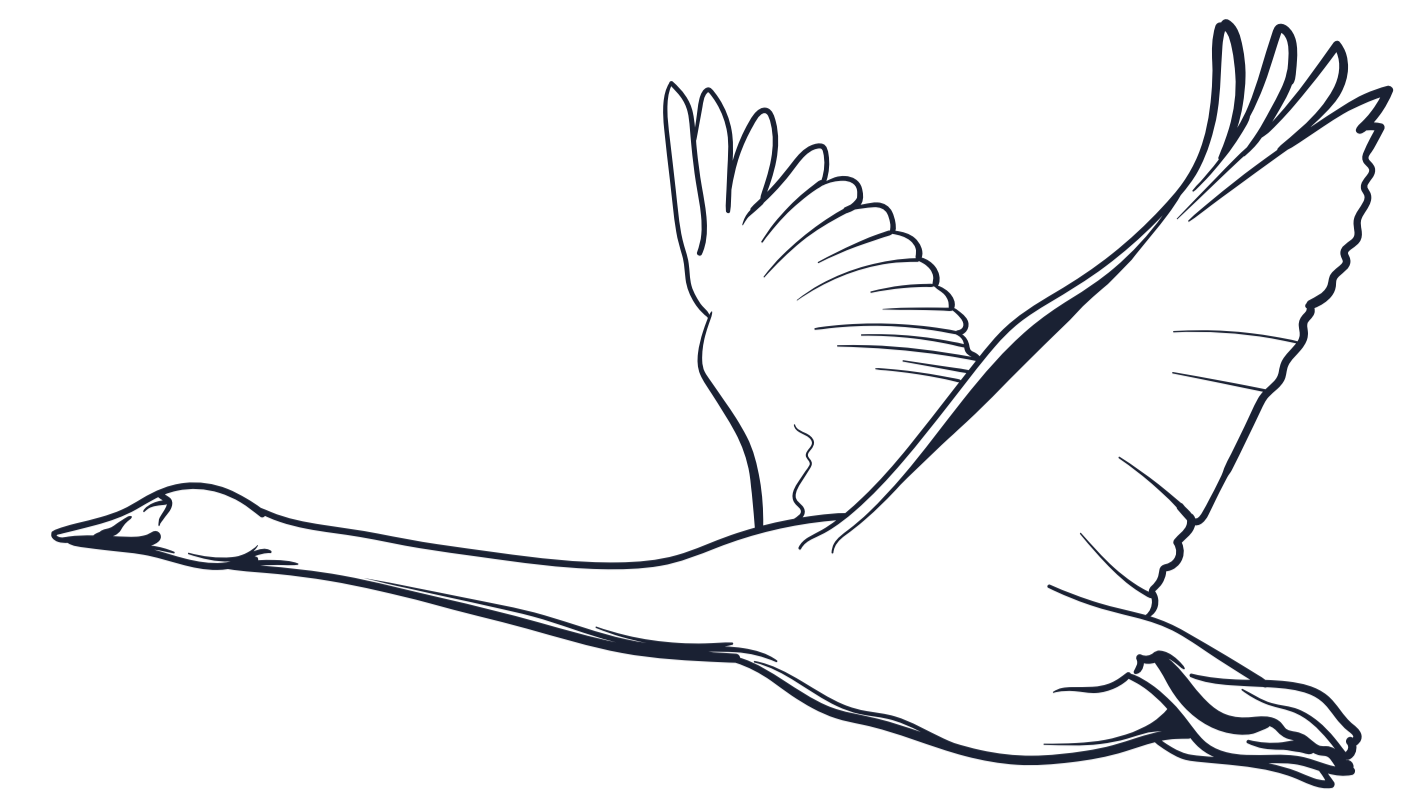

Introducing NatPower

NatPower UK is part of the NatPower Group, an independent, well-capitalised energy enabler, with 25 years' experience and 30GW of assets developed across 20 countries and six continents.

We are making a meaningful contribution to the UK's need for clean, secure and affordable energy. By delivering more than 60GWh of energy storage across the country, we are aiming to provide 20% of the energy storage requirement of the UK by 2040. We are also bringing forward wind and solar farms in different places to contribute cleaner energy for the UK.

We develop, build and manage our own projects. That means that we are long-term partners in our communities – and we look to work with local residents, businesses and community groups to bring the benefits of the clean energy transition to the places we operate. That includes designing our projects in a way that is sensitive on the environment and our neighbours – but it also means investing directly into our communities to assist them in becoming the most sustainable in the UK.

You can learn more about NatPower's Community Energy Transition Foundation here at our event today.



**60GWh of
energy storage**
across the UK.

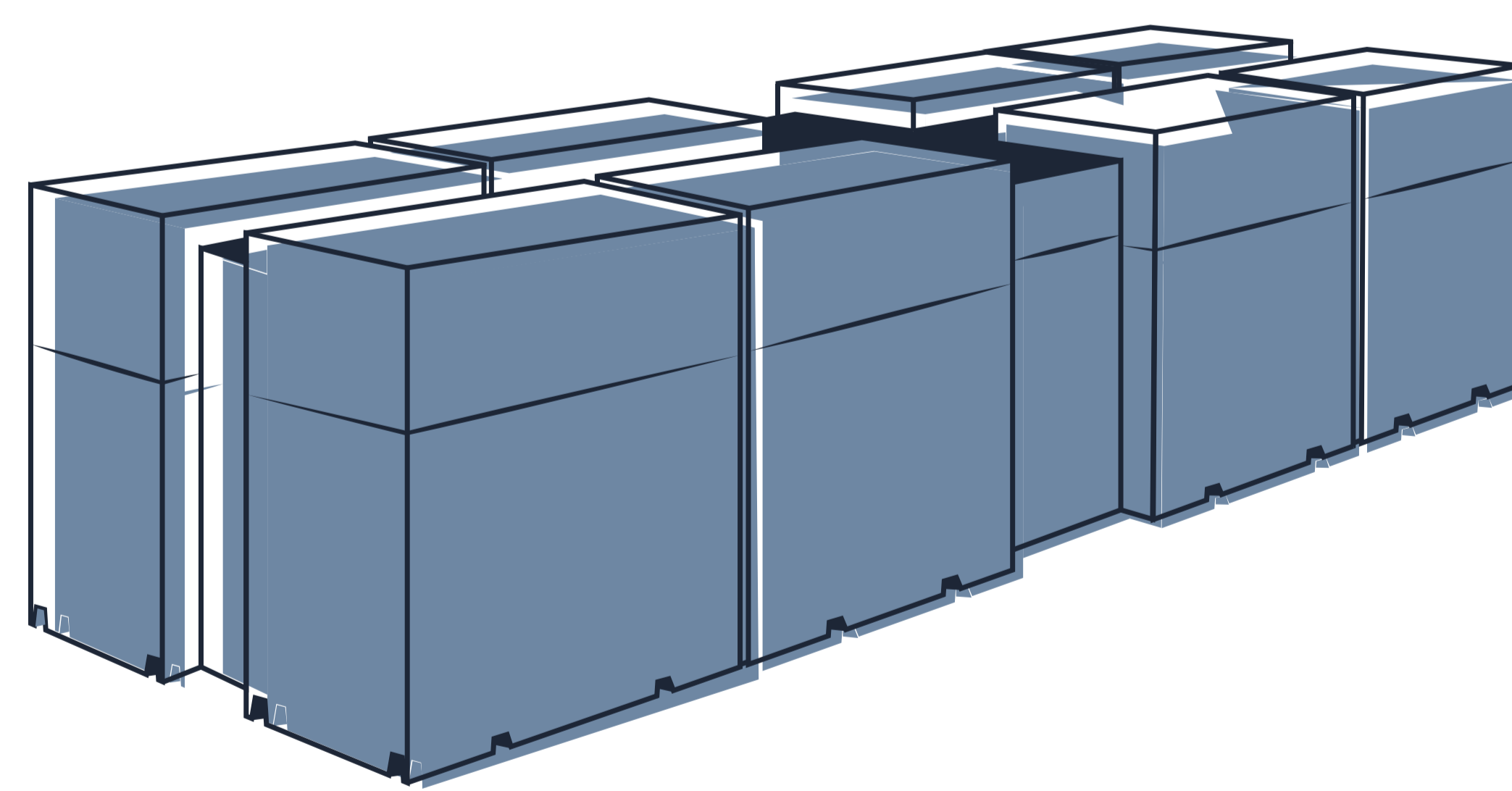

**20% of the energy
storage requirement**
of the UK **by 2040.**



Battery storage - the need

The UK is committed to achieving net zero by 2050 and expects to completely decarbonise its energy network by 2035. In the future, wind and solar will be the main ways that we generate energy across the UK.

We are forecast to use more electricity in future. As we stop using fossil fuels to power our cars and heat our homes, the country expects to double the amount of electricity it uses by 2050.

That means we need access to reliable, consistent supplies of electricity. Battery storage has a vital role to play: wind and solar farms don't generate electricity consistently, but batteries allow us to store electricity and release it at times when it is most needed.

The United Kingdom imported 37% of its primary energy in 2022 from foreign countries. This leaves us vulnerable to price increases when there are issues with supply abroad. Battery Energy Storage will help to keep electricity affordable and our supplies secure.

By adopting this sustainable approach, we can help to ensure a cleaner, more secure energy supply for future generations.

nu

How energy storage works

1

Battery energy storage system (BESS): Enable us to capture and store energy when supply exceeds demand. They then release that power back to the grid later, when it is needed, so that we have a steady and reliable supply of energy at all times.

2

Inverters: Battery systems store and deliver electricity as Direct Current (DC) while most electrical systems operate on Alternating Current (AC). The BESS includes inverters to change the electricity from AC to DC and back.

3

A substation: A substation connects the project into the National Grid. A substation typically appears as a collection of electrical equipment and towers, sometimes connecting to overhead powerlines by cabling.

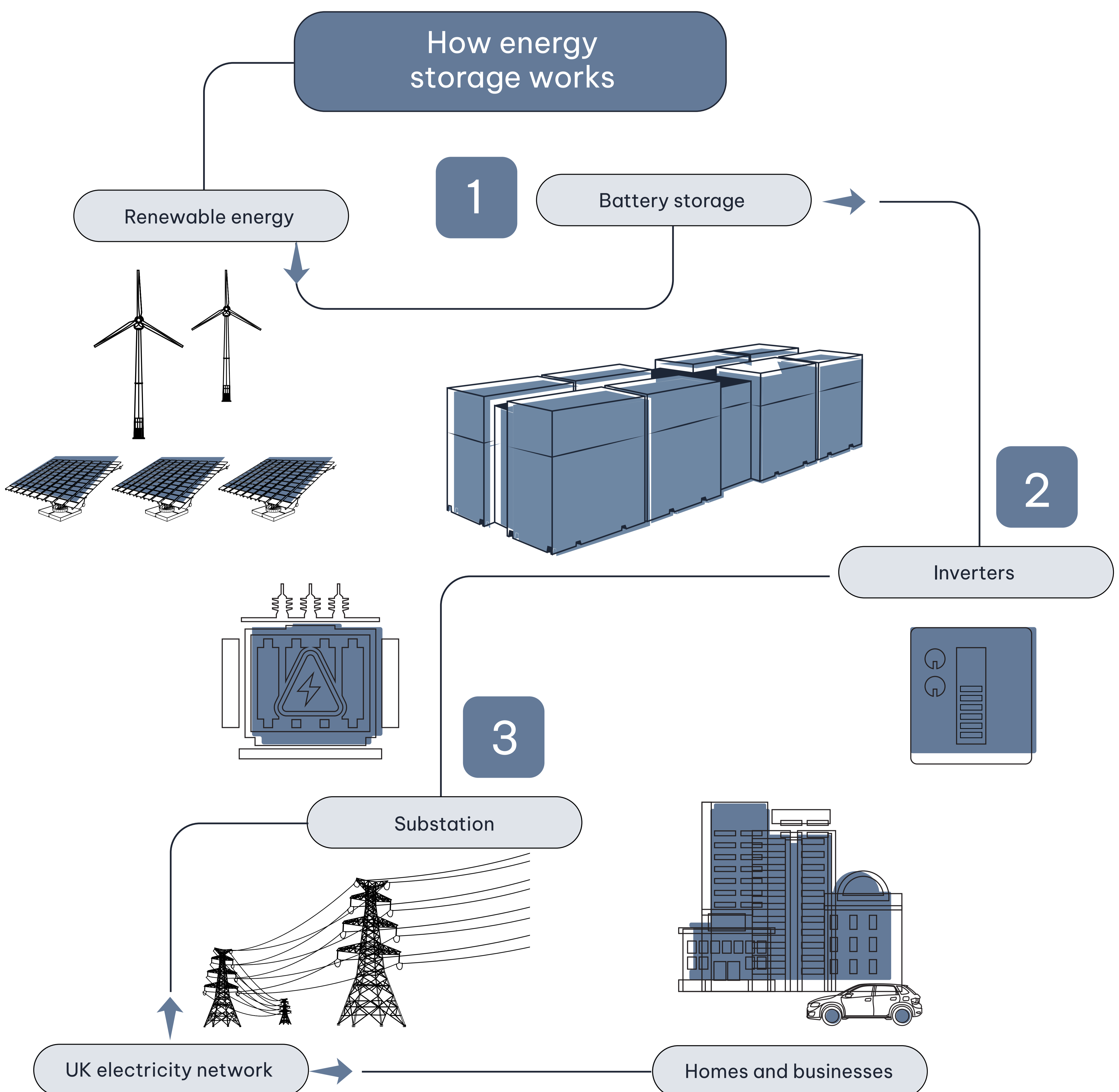

Battery storage - what's involved

1

The BESS contains a number of components, all housed in units similar in size and shape to shipping containers, about 12m in length and 2m-3m high.

Lithium Iron Phosphate batteries store energy ready to be supplied when needed. These are stacked on top of each other to form a battery rack and are connected together to reach the required voltage and current of the BESS. These are a tried and tested technology that is commonly used in our day-to-day lives, such as in smartphones.

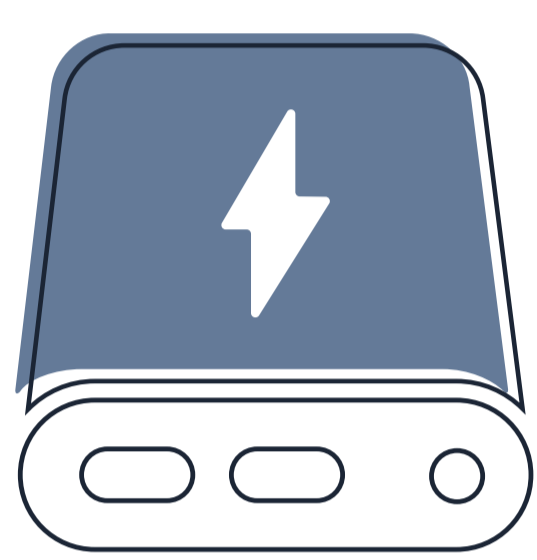
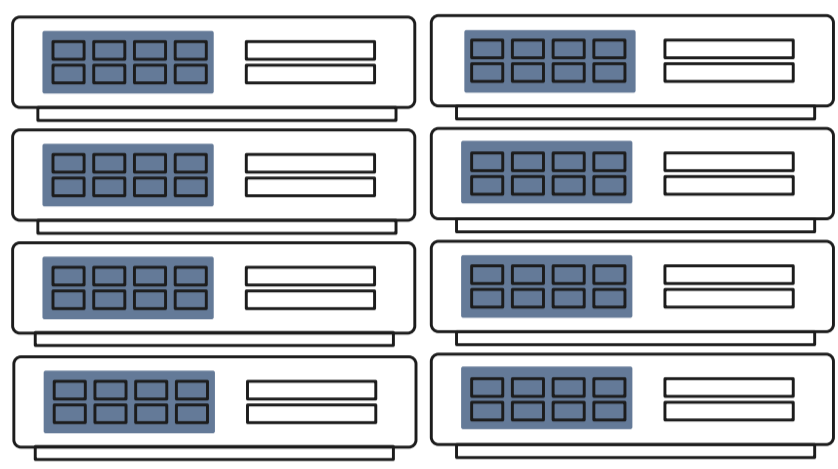

The battery management system is the brain of the BESS and works to safeguard the batteries from damage in various scenarios. It constantly monitors the state of charge, state of health, voltage, temperature and current. It ensures the safety and longevity of the batteries.

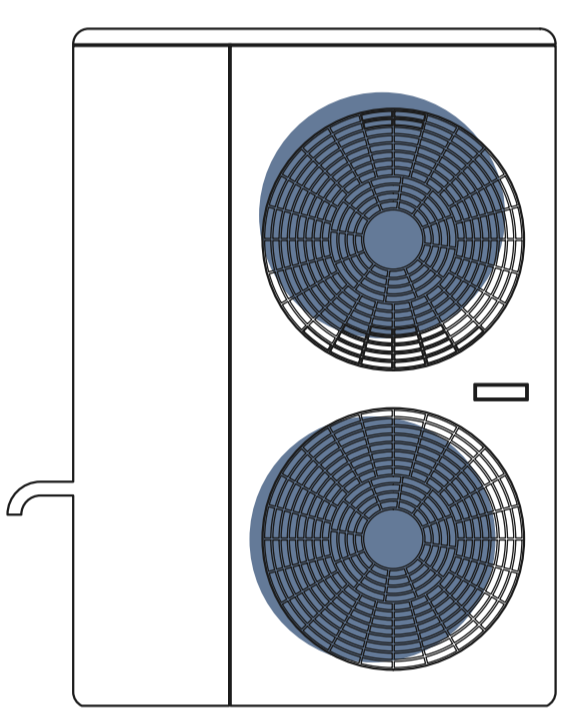

A heating, ventilation and air conditioning system controls the operating temperature within the system's enclosure and ensures good air distribution. This prevents the batteries from overheating, which in turn means that the batteries last longer and perform better.

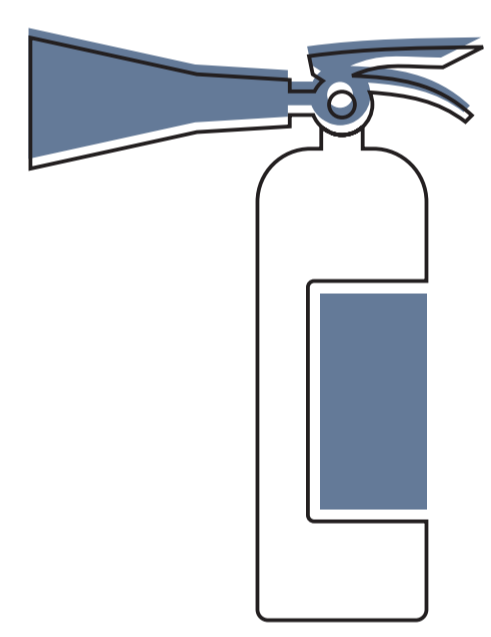

A fire suppression system is built into the design of the BESS and would only operate in the unlikely event of overheating of the batteries.

2

Security: The BESS and substation will be secured by metal security fencing and monitored by a CCTV system, which will face the battery storage and substation areas. We will use motion sensor lights to keep lighting to a minimum.

3

Landscaping: Our projects include landscaping to screen the BESS from view.

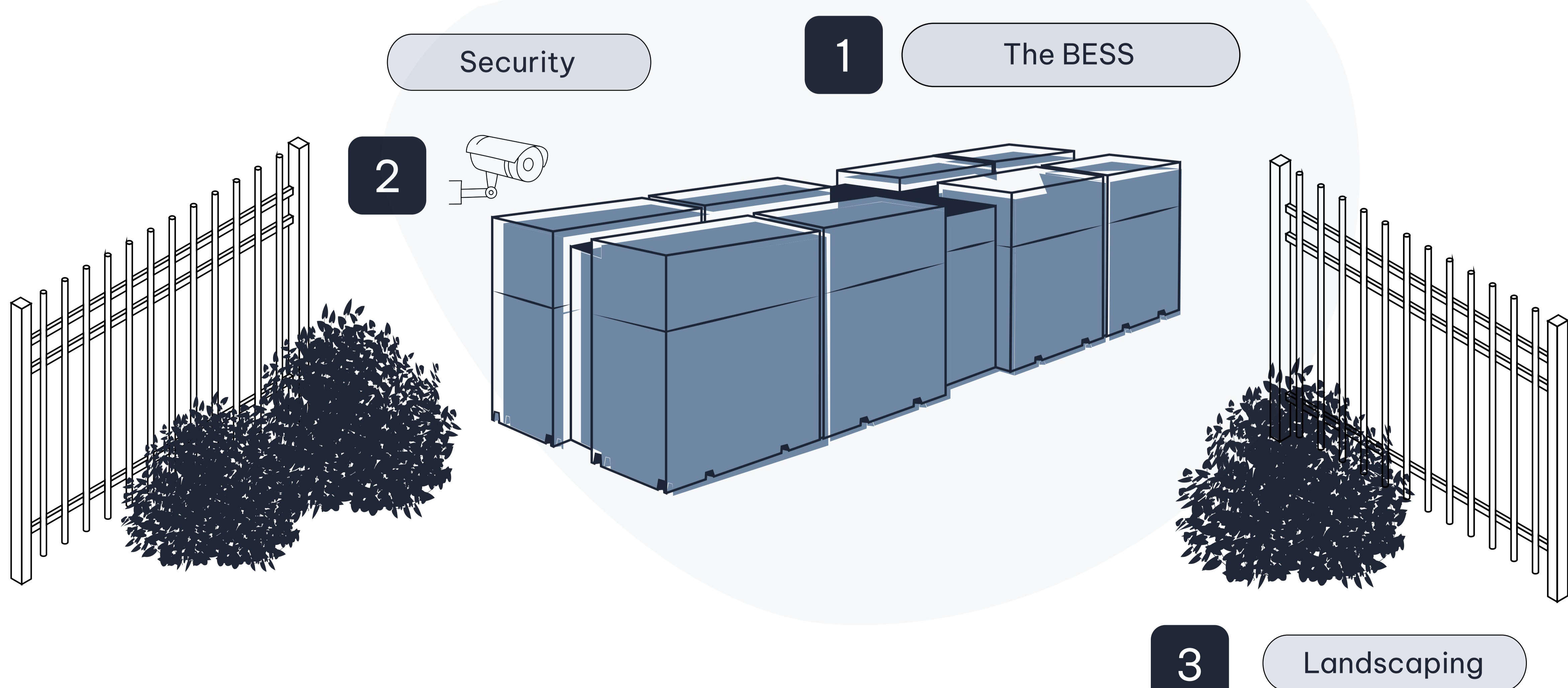

Our Proposals - Summary

Brant Energy Storage is a proposed 1GW Battery Energy Storage System (BESS), located on on land to the west of Coleby, and South of Hill Rise, in Lincolnshire.



The land within our proposal is approximately 35 hectares (89 acres), which will include infrastructure and landscaping to ensure long-term environmental benefits for Lincolnshire.

Our proposals will deliver an increase in biodiversity net gain substantially above the industry standard and allow nature to thrive.

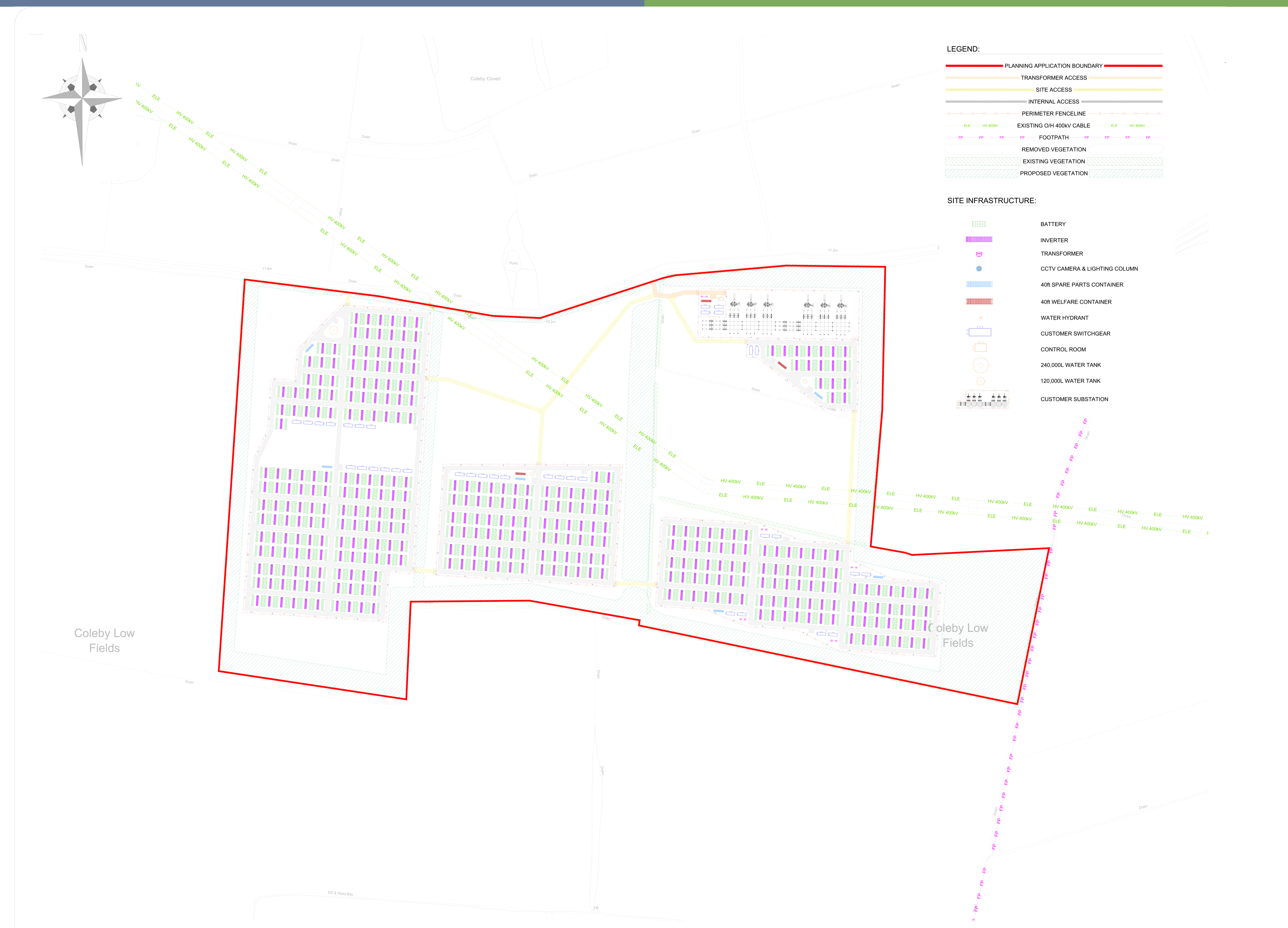

Project Timeline



Summer 2024

Environmental and ecological surveys underway underway, including for breeding birds and water voles



Spring 2025

Finalisation of survey work and preparation of planning work
Consultation with community and key stakeholders

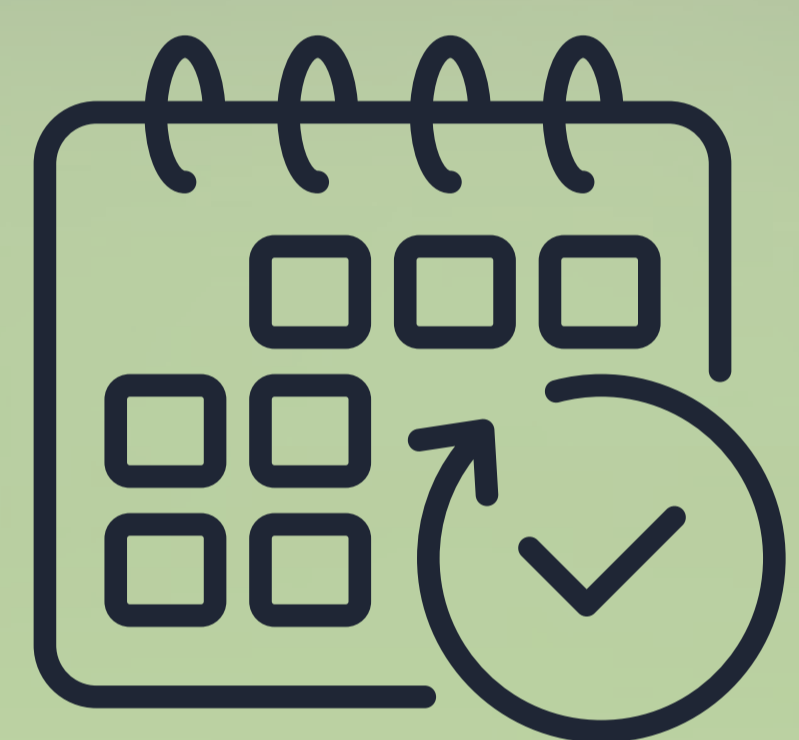

Winter 2025

Application decision issued by North Kesteven District Council

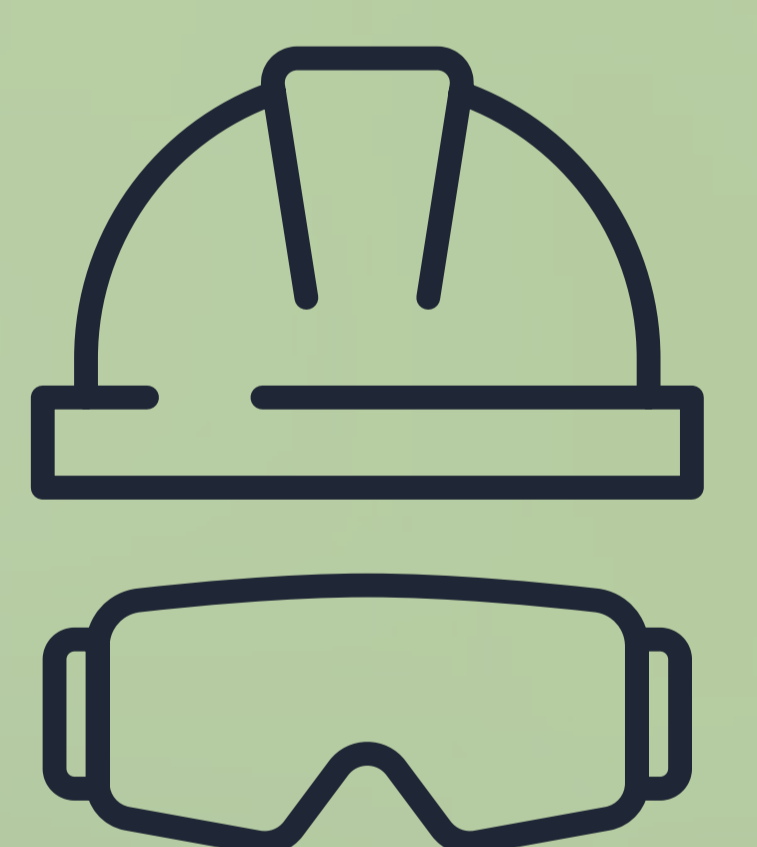

Summer 2028

Construction begins



2030

Construction complete



Construction and Operation

Construction

Upon securing planning permission, we expect to start construction in Summer 2028. The level of activity on site would vary throughout this period.

NatPower will prepare a Construction Traffic Management Plan (CTMP) and agree this with North Kesteven District Council. The CTMP will set out how we will manage construction activities and any traffic moving to and from the site.



90 FTE Jobs

Construction jobs

(During the peak of the construction phase)



110 FTE Jobs

Supply chain jobs

(During the peak of the construction phase)



£8.1m GVA

Gross value added

(throughout the peak of the construction period)



£150,000 per annum

Business rates

For construction, access to the site will be provided from Hill Rise. As part of the CTMP, it is proposed to route construction vehicles from the A15 Sleaford Road to the site via the B1178 Tower Lane, Church Lane/Station Road, Broughton Lane and Hill Rise.

There will be around 90 jobs on-site during construction, as well as opportunities for local businesses to become involved in the supply chain. Where possible, we will look to procure suitably qualified local suppliers to help us deliver the project. If you are interested, please register your company details with our team.

Operation

BESS are generally quiet neighbours and, once operational, traffic movements to and from the site will be low. A team of qualified engineers will monitor our BESS 24/7 from an offsite location. An engineer would routinely visit our sites in a small vehicle two or three times a week to inspect the BESS and associated infrastructure.

The BESS and substation will be secured by security fencing and monitored by a CCTV system, which will face the battery storage and substation areas. We will use motion sensor and infra red lights to keep lighting to a minimum.

Community Energy Transition Foundation

We are committed to supporting our communities through a **Community Energy Transition Foundation**, which invests in those areas where we have operational sites. The Foundation receives funding from each site, proportionate to its size.

We expect this project, if approved, to contribute around £1 million each year.

With that funding, the Foundation can then provide substantial financial support to individuals, businesses, charities and community groups to promote sustainable communities and provide a financial stimulus for the green transition in your area.

That's why we would like to hear from you about what your community needs to become more sustainable and how the Foundation could help.

The types of projects that will be considered for funding include:

- Emissions reduction
- Habitat enhancement
- Energy efficiency
- Education/skills support
- Sustainable transport
- Green economy
- Sustainable agriculture

In terms of practical application, the fund could potentially invest in initiatives such as:

- Electrification of vehicle fleets, including tractors and trucks;
- EV community pool cars;
- Small-scale solar generation;
- Battery tools for use in expanded allotments.

Speak to a member of the team for more information

Next Steps

Thank you for taking the time to learn about our plans. Your feedback is invaluable and, where possible and appropriate, we will look to incorporate your comments into our evolving proposals.

Please complete a feedback form and let us know what you think. You can fill one out here today or go to our project webpage for an online form (QR code below).

All feedback should be returned to us by 11 April 2025.

We will consider all feedback and finalise our plans to submit a planning application to North Kesteven District Council. As part of the application, we will submit a document that summarises the community's comments and the engagement undertaken for the project (known as a Statement of Community Involvement).

North Kesteven District Council will then conduct its own statutory consultation before determining the application. This will provide stakeholders, residents and other interested parties with another opportunity to provide feedback on our proposals.



Find out more

→ www.natpower.uk/our-projects

